

# UniDropper Neo 10 ml, 15 ml, 30 ml - filling and assembling

**Recommended closing force (to put dispensing stopper on the container):**  
- PE dispensing stopper: 10kg (100N)  
- PE dispensing stopper with ALU shroud: 82kg (800N)

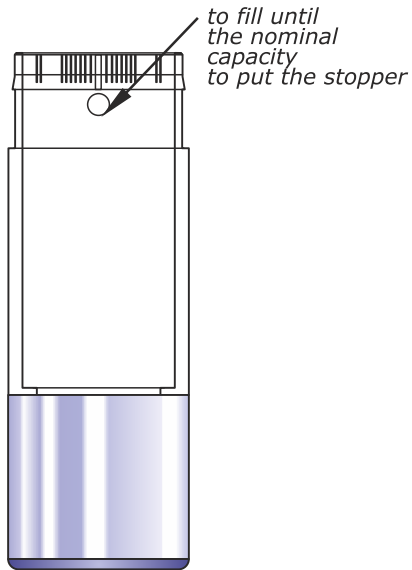
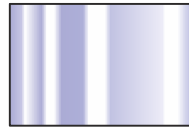
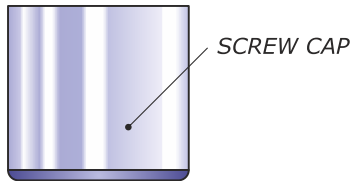
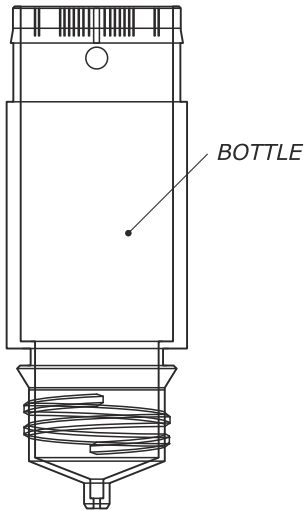
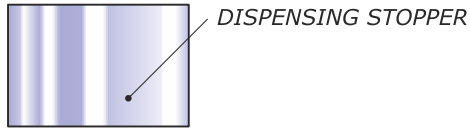

**SCREW CAP and BOTTLE delivered assembled**

**Push until the DISPENSING STOPPER stops on the stepped edge of BOTTLE.** !

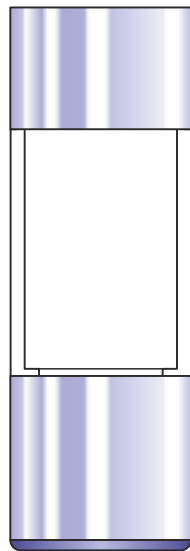

READY TO USE

**There can't be any gap between the DISPENSING STOPPER and the BOTTLE stepped edge.** !

Unscrew the cap, press the dispensing stopper

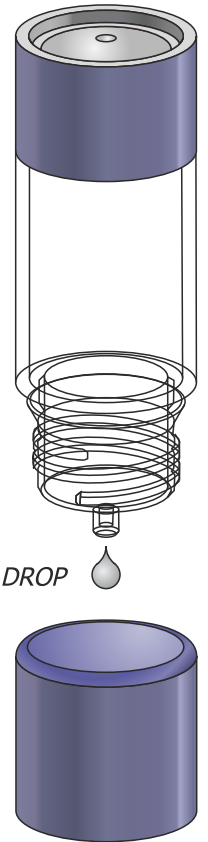

1 PUSH = 1 DROP